

CUDDLER DIRECTIONS

Quilts from Caring Hands trusts that you will sew the Cuddler with the joy of giving. Please do not sell the directions or any Cuddler made with them, rather share them freely with children and their families who need a little extra Tender Loving Care.

Supplies for cover ...

Base fabric – good grade muslin or cotton, 15" x 20"

Scraps of tactile fabrics – strips or scraps to be pieced to be 13"-14" – varying widths

Scraps of cotton quilting fabric – one strip 4" x 14" and one circle 4 ¼" diameter

Cording - 15" or so

Black fabric marker

Supplies for pillow insert ...

Scraps of batting – enough to make a pillow roll 15" long x 4" diameter (equivalent to a strip of batting 110" long and 15" wide).

Nylon stocking

Directions ...

Use the black marker to draw a 12 ½" x 15" rectangle on the base fabric beginning at the raw edge of Side A. The color will bleed through so the line can be seen on the wrong side of the fabric.

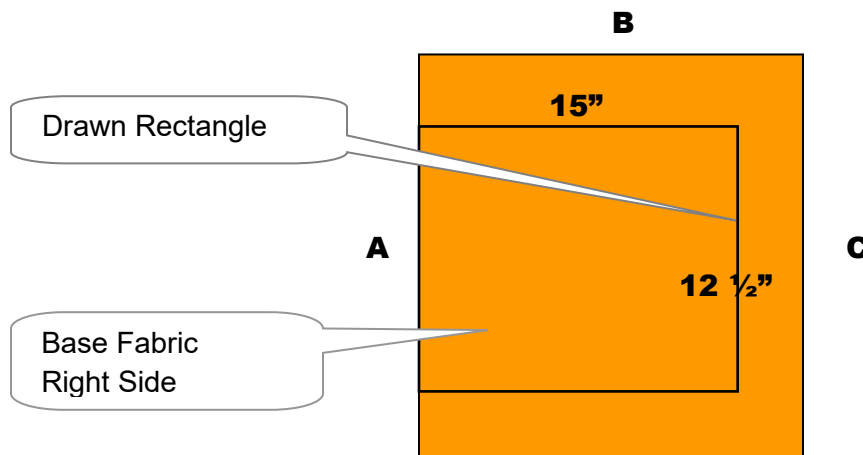

1. Sew tactile fabrics and cotton strip to the base fabric
 - a. Beginning at Side A of the rectangle, place the 4" x 14" cotton fabric strip wrong side down on the base fabric, extending the raw edge of this strip 2 ½" beyond the edge of the base fabric. (This will become the casing in Step 4.) Stay-stitch the opposite long edge of this strip to the base fabric 1/8" from the raw edge. (See Diagrams) The short ends of the strip will extend past the drawn line on Sides B and D.

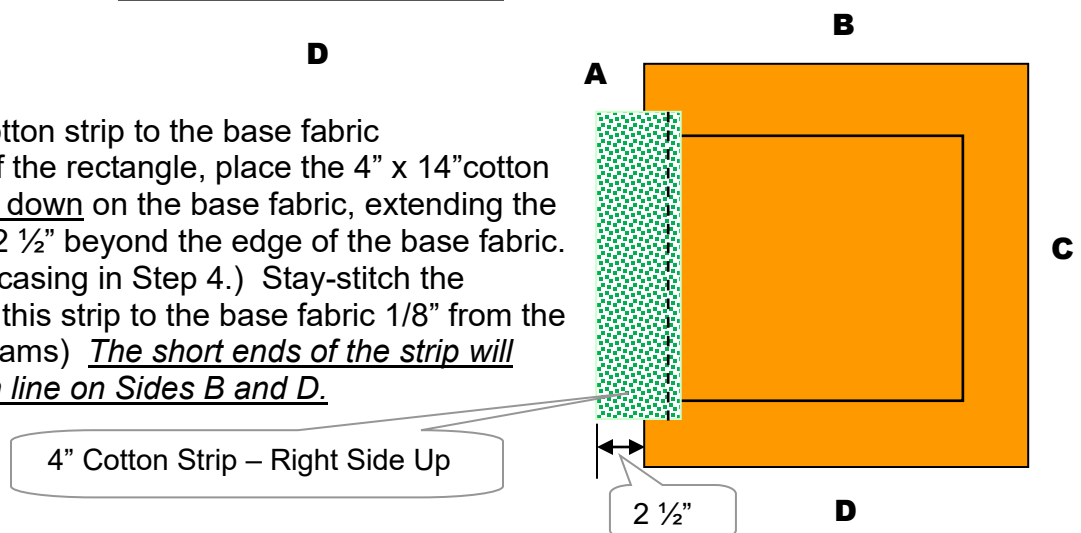

- b. Place a tactile strip on the cotton strip, right sides together, being sure the ends extend past the drawn line. Pin in place. Sew using $\frac{1}{4}$ " seam. Flip the strip toward the base fabric and stay-stitch down. Press seam gently from the back.

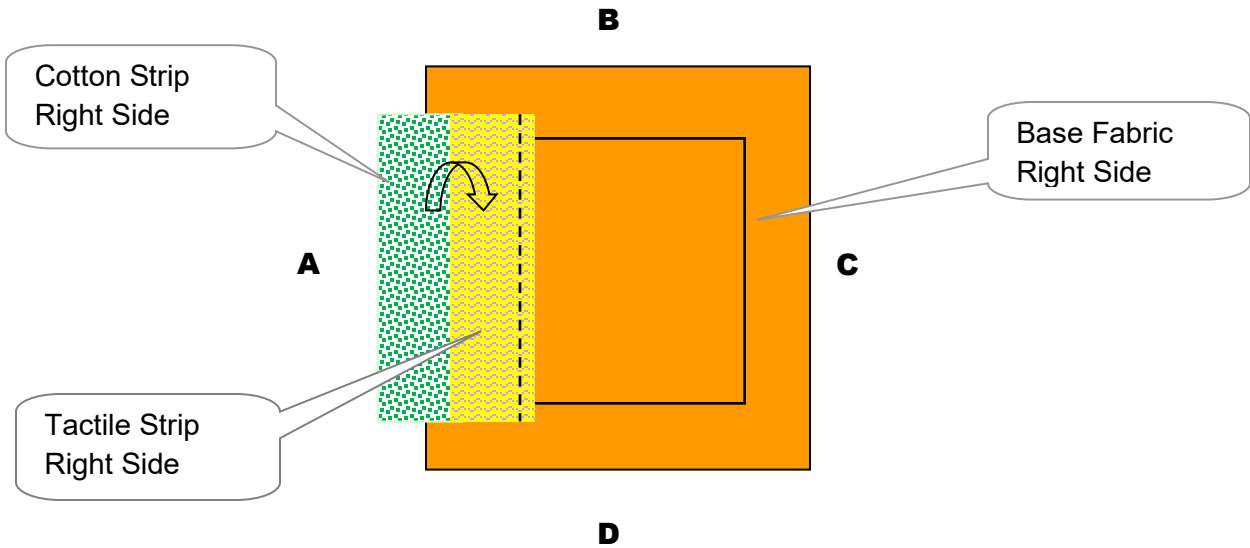

- c. Continue sewing and flipping the tactile strips to the base fabric. Press gently as you sew on each strip. Adjust the width of the tactile strips as you sew so the last tactile strip meets the drawn line on the other end of the base fabric (Side C).

Note: Do not use a heavy tactile fabric for the last tactile strip.

2. Turn the Cuddler over. On Side A, fold under $\frac{1}{4}$ " on base fabric – raw edge toward the wrong side of the cotton strip. Pin in place.

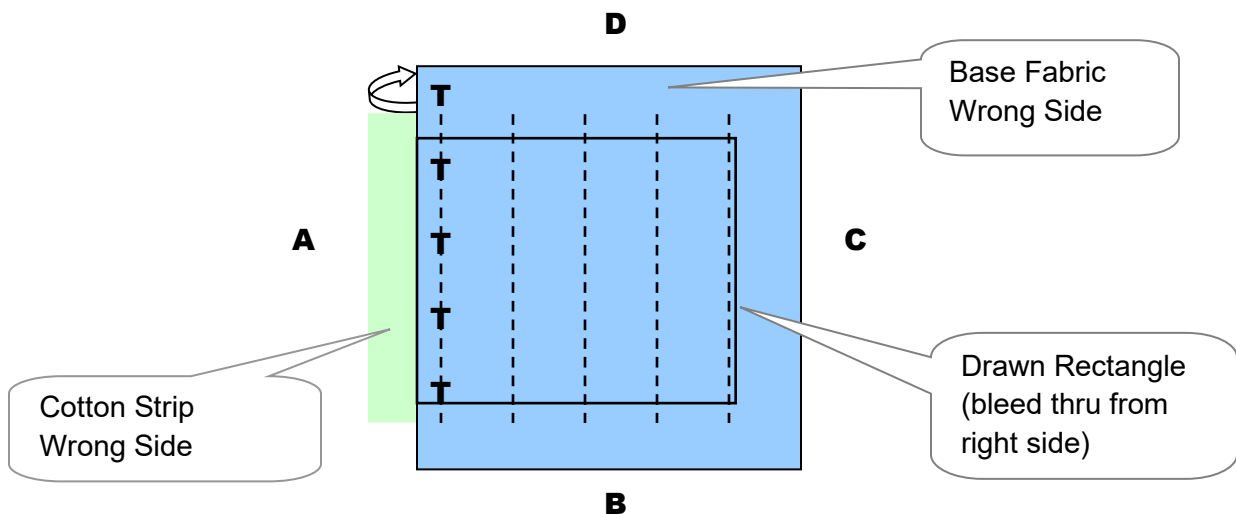

3. Sewing on the wrong side, zigzag Sides B, C and D on the drawn line. Also zigzag the cotton strip on Side A which is a single layer of fabric. Trim away the excess fabric from the zigzagged edges. Be careful not to cut the stitching.

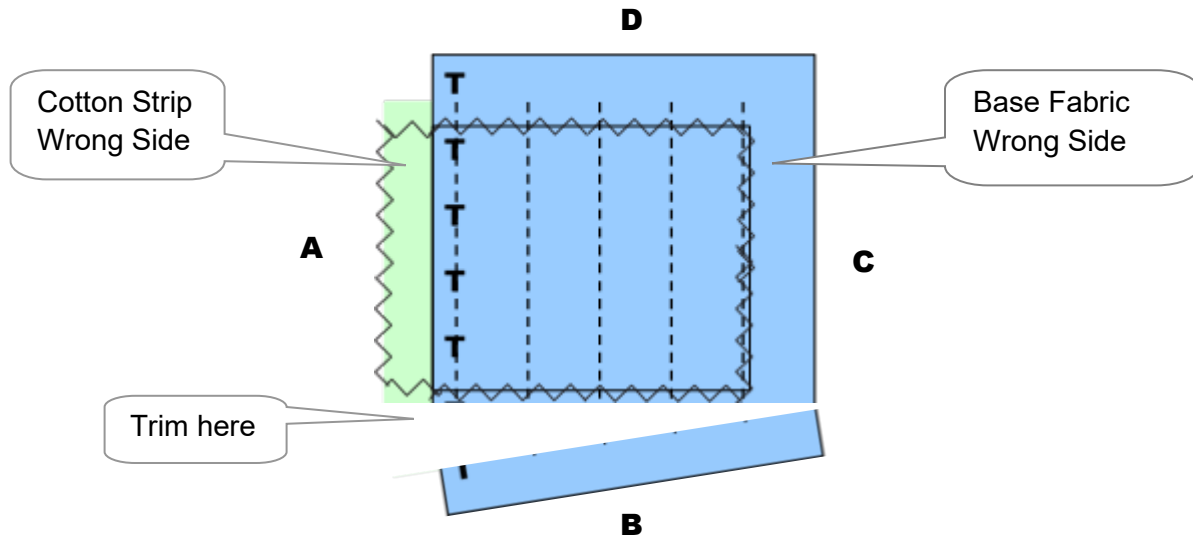

4. Turn under $1 \frac{3}{4}$ " on the cotton strip (Side A). Press. Slip the raw edge of the cotton strip under the base fabric $\frac{1}{4}$ " hem that you turned under in Step 2. Stitch in place through all layers {a}. Stitch $\frac{1}{2}$ " from the folded edge of the cotton strip {b}. This creates the casing.

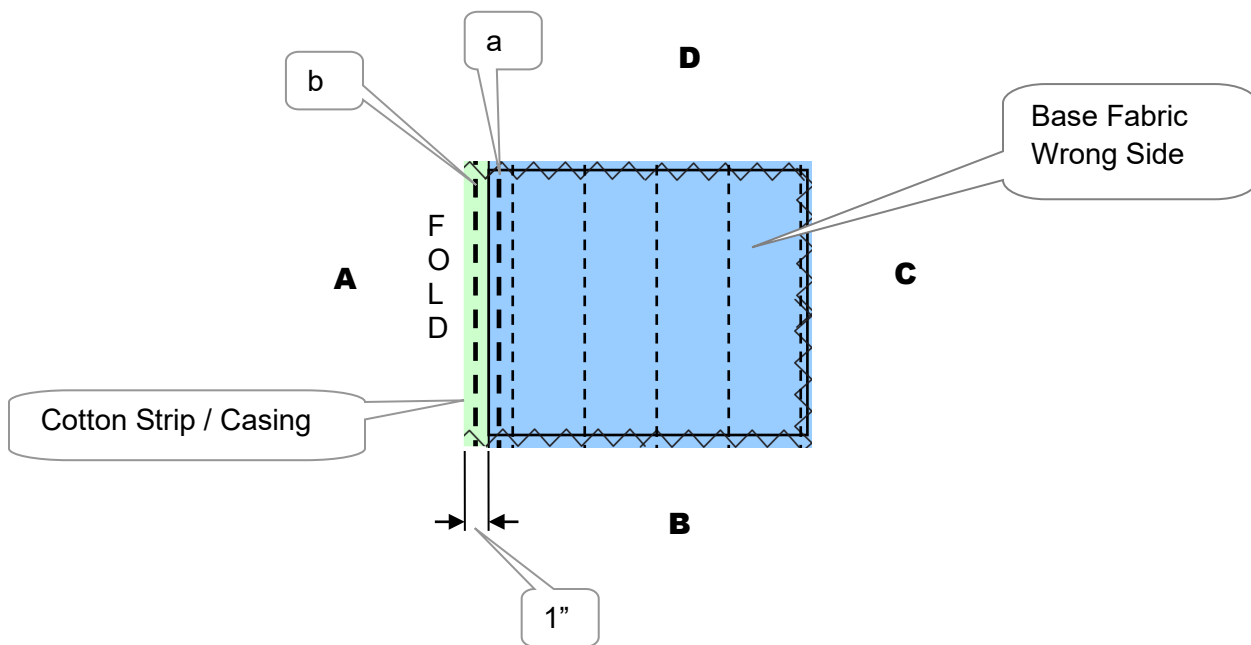

5. Feed cording through the casing. Find the center of the casing and the cording. Match the two centers and stay-stitch the cording in place by stitching through the casing and cording.

6. With right sides together, stitch the long side of the Cuddler (Side B and D) using a generous $\frac{1}{4}$ " seam. Begin stitching $\frac{3}{8}$ " from the folded edge of the casing to leave room for the cording.

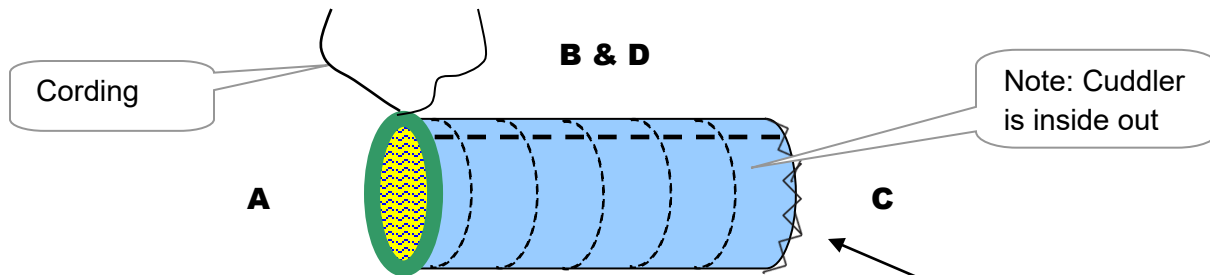

7. Stitch the cotton circle to the non-cording end of the Cuddler (Side C).
- Fold circle in half and mark. Fold in half again and mark. Do the same with the Cuddler.
 - Matching the marks pin circle to the Cuddler – right sides together. Pin carefully.
 - Stitch using a generous $\frac{1}{4}$ " seam.

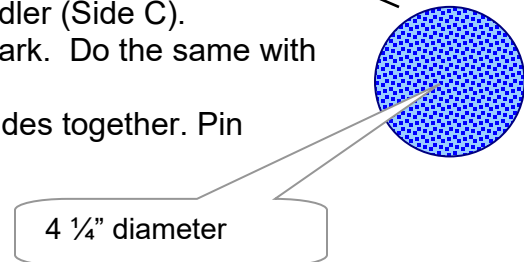

8. Turn Cuddler right side out.
Make the pillow insert. See Directions below.

Directions for the pillow insert ...

1. Sew (use a large zigzag) batting scraps together to make a strip 15" wide x 110" long.
2. Roll up to a 4" diameter.
3. Secure batting by hand stitching the end to the roll itself.
4. Put batting roll into nylon stocking. Tie a knot in the nylon. Stuff the knot into the batting roll.

Finishing the Cuddler ...

1. Put the pillow into Cuddler.
2. Pull the cording to gather the one end of the Cuddler. Tie the cording so it can be untied. Push the bow into the drawn up opening. This way the cover can be removed before washing.

Pressing concerns ...

Many tactile fabrics may melt or shrink when pressed. Use a **warm** iron – **not hot**.
When possible press from the wrong side.
Use a pressing cloth when pressing on the right side of the fabric.

Washing instructions ...

The Cuddler is machine washable and machine dryable.
The cover is removable so the cover and pillow may be washed separately.
The entire Cuddler – cover and pillow - may be washed and dried together.